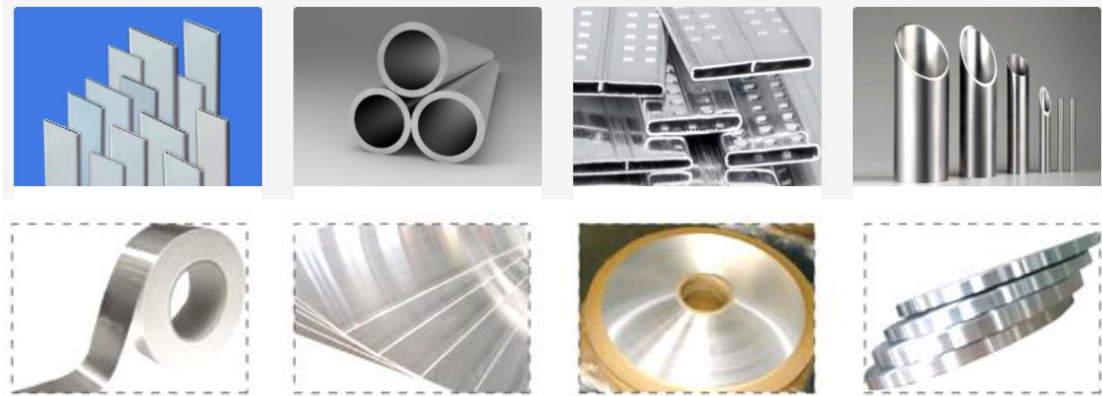







Table of Contents

Aluminium Material for Heat Transfer.....	- 2 -
Aluminium Micro-channel Tube.....	- 3 -
➤ Product Category.....	- 3 -
➤ Product Dimension Control Range.....	- 3 -
➤ Tolerance.....	- 4 -
➤ Coating Standard and Corrosion Resistance.....	- 4 -
➤ Chemical Composition.....	- 4 -
➤ Mechanical Properties.....	- 4 -
➤ Three Kinds of Coating Solutions.....	- 5 -
➤ Micro-channel Technology in Heat Exchanger.....	- 5 -
Aluminium Drawn Tube.....	- 6 -
➤ Product Category.....	- 6 -
Aluminium High Frequency Welded Tube.....	- 9 -
➤ Product Category.....	- 9 -
Composite Aluminium Tube (Al-Al Composite Tube).....	- 15 -
Aluminium Foil For Air Conditioner.....	- 16 -
Aluminium Clad Foil For Heat Transfer.....	- 17 -

Aluminium Material for Heat Transfer



-  Aluminium Micro-channel Tube
-  Aluminium Drawn Tube
-  Aluminium High Frequency Welded Tube
-  Composite Aluminium Tube (Al-Al Composite Tube)
-  Aluminium Foil for Heat Transfer (Clad/Bare)

Note: Customization is available, please contact us for details.

Aluminium Micro-channel Tube

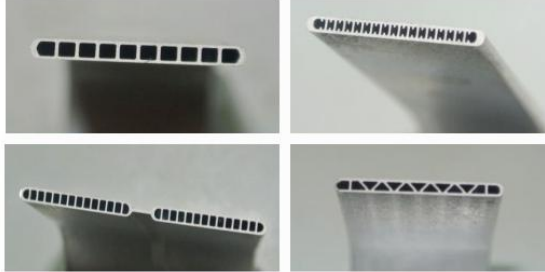

Description: Aluminium Micro-channel Tube is a kind of high precision extruded aluminium tube, also called multi-port extrusion tube (MPE tube) and aluminium micro multi-channel tube. This flat and rectangular extruded tube is made of

several channels that increase the heat transfer through a higher surface per volume ratio.

➤ Product Category

- Aluminium Micro-channel Tube
- Aluminium Multi-Port Tube
- Parallel Flow Aluminium Flat Tube
- Zinc-coated Aluminium Tube
- Pre-Flux Coated Aluminium Tube
- Si Flux Coated Aluminium Tube
- Large Multi-channel Tube (width range 50-200mm)
- Double Row Joint Multi-channel Flat Tube

➤ Product Dimension Control Range

Item	Range
Fixed length	200mm-4000mm
Width (micro-channel tubes)	8mm-60mm
Width (large multi-channel)	60-200mm
Thickness	1mm-5mm
Wall thickness	0.15mm-0.6mm
Thickness of zinc spraying	5g/m ² -15g/m ²
Thickness of flux coating	8g/m ² -25g/m ²

➤ **Tolerance**

Width	Thickness	Wall Thickness	Length	Straightness (side)	Straightness (front)	Twisty
±0.04mm	±0.03mm	±0.05mm	±0.30mm	≤L*0.2%	≤L*0.25%	≤L*0.15%

➤ **Coating Standard and Corrosion Resistance**

Corrosion resistance (common alloy)	Salt spray test: ≥750 hours
Zn Coating standard	8±2g/m ² , 10±2g/m ² , 13±2g/m ²
Flux Coating standard	10-15±2g/m ²



➤ **Chemical Composition**

No	Alloy Grades	Si	Fe	Cu	Mn	Mg	Cr	Zn	V	Ti
1	1050	≤0.25	≤0.40	≤0.05	≤0.05	≤0.05	—	≤0.05	≤0.05	≤0.03
2	1100	≤0.95(Si+Fe)	—	0.05~0.20	≤0.05	—	—	≤0.10	—	—
3	1197	≤0.15	≤0.20	0.40~0.55	0.10~0.20	≤0.03	≤0.05	≤0.05	≤0.05	≤0.05
4	3102	≤0.40	≤0.70	≤0.10	0.05~0.40	—	—	≤0.30	—	≤0.10
5	3R03	≤0.15	≤0.15	≤0.01	0.90~1.10	≤0.03	≤0.03	≤0.05	≤0.05	≤0.05

➤ **Mechanical Properties**

No.	Alloy Grades	Temper	Tensile Strength	Yield Strength	Elongation
1	1050	O/F/H1111/H112	≥65	≥20	≥25
2	1100	O/F/H1111/H112	≥75	≥20	≥25
3	1197	O/F/H1111/H112	≥80	≥25	≥20
4	3102	O/F/H1111/H112	≥75	≥20	≥25
5	3R03	O/F/H1111/H112	≥80	≥25	≥20

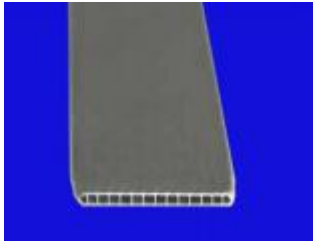
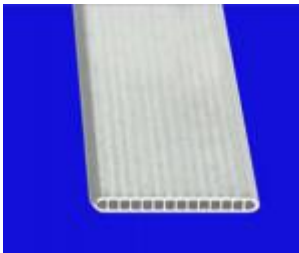
➤ **Three Kinds of Coating Solutions**

Coating Material	Flux Coating	NOCOLOK Si Flux Coating	Zinc Coating
Sample Images			
Main Components	Flux(K1-3A1F46)	NOCLOK F1ux: 66.6% Silicon Powder: 33.3% Or according to customers requirements	Zinc powder
Features	No need for extra brazing in brazing line but use aluminium fin material with a layer	The Si-flux to spray solder flux when brazing and the fin material can be bare foil	The tube with zinc-coated will highly enhance corrosion resistance performance

➤ **Micro-channel Technology in Heat Exchanger**

- Reduce your system refrigerant charge by as much as 35 %.
- Improve your energy efficiency/coefficient of performance by up to 10 %.
- Reduce your raw material consumption by more than 40 %.
- Reduce your manufacturing cost compared to aluminium and copper heat exchangers.
- Easily recycle.

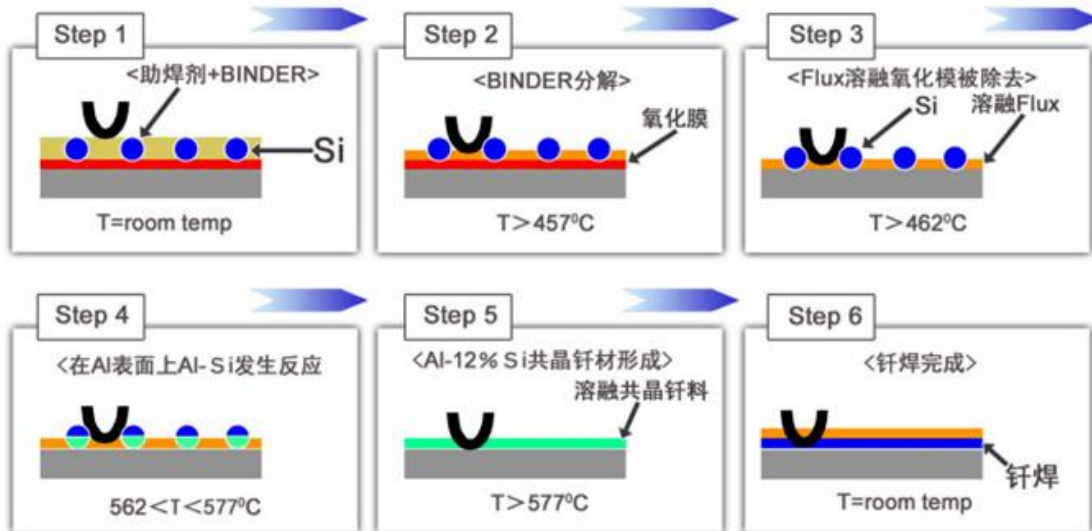

Aluminium Drawn Tube

➤ Product Category

a. Round Aluminium Drawn Tube (Aluminium Smooth Tube)

❖ Application

- Aluminium round drawn tube for parallel flow heat-exchanger, water tank, radiator.
- Billet of condenser header pipe and condenser drier, such as specifications: OD: $\phi 20 \sim \phi 50$, thickness: 8~1.2.
- Connecting tubing for auto, we provide bending service.
- Can be used as a large air-cooling tube, such as 1050 aluminium drawn tube $\phi 25 \times 0.6 \sim 1.5$, $\phi 28 \times 0.8 \sim 1.5$.
- The high anti-corrosion alloy drawn tube for solar thermal.

❖ Specifications

◆ Round tube

Outer Diameter	$\Phi 4.0 \sim \Phi 60$ mm
Wall Thickness	0.2 ~ 2.5 mm
Aluminium Alloy	1050/1060/3003/3103/3A21/5049, 5086/6063, etc.

◆ Round coil

Outer Diameter	$\Phi 4.0 \sim \Phi 15.88$ mm
Wall Thickness	0.22 ~ 1.5 mm
Aluminium Alloy	1060/1070/1100/3003/6063

b. Aluminium Alloy Capillary



Description: The aluminium capillary is a kind of small diameter cold drawn tube. Generally, it is made of pure aluminium. The outer diameter can be less than 4mm, and the wall thickness can be 0.25mm.

Application: Air condition, refrigeration (return pipe for refrigerator), cooling system and precision equipment; such as household refrigerators, electric freezers, and other

high-precision instruments.

c. Aluminium Peanut Tube

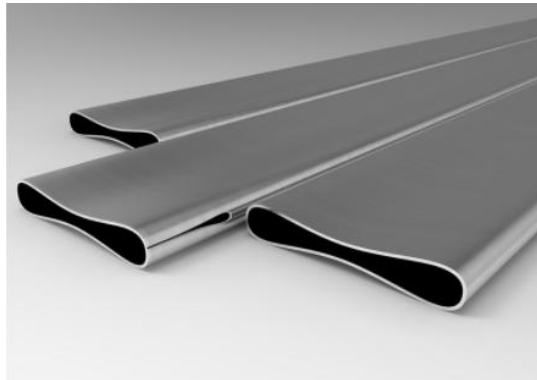

Description: It is used for car radiators and water tanks. This kind of radiator tube achieves better heat transfer efficiency and saves material costs.

Specification: 7*0.25 in stock, OEM service available.

d. Aluminium Drawn Profiles (Plate and Bar Profiles)



Description: You can use precision-drawn aluminium profiles in plate-and-bar heat exchangers for trucks, industrial applications, agricultural machines, and wind turbines. Such heat exchangers are solid and robust, and popular due to the flexibility of the technology, representing an attractive advantage to copper.

e. Aluminium Inner Grooved Tube (Internal Toothed Tube)

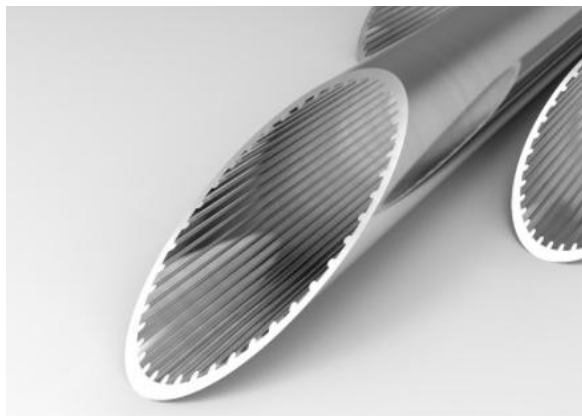

Description: An aluminium inner-grooved tube also called an internal toothed tube, is the lightweight and cost reduction solution for air conditioning heat exchanger, representing an attractive alternative to copper tube. The inner grooves can be straight or helical. The height range of inner grooves varies from 0.05 to 0.3mm. The higher groove, the better heat transfer performance.

❖ Specifications

Specifica tions OD:	Bottom Wall Thic kness (m m)	Groove H eight (m m)	Tooth Numb er	Helix angle (degree)	Groove top a ngle (degree)	Weight per met er
Φ5.0 ~ Φ15.88 mm	0.35-1	0.05-0.3	20-70	0 ~ 25	30 ~ 135	
φ5mm	0.35-0.5	0.05-0.25	40-50	18°	50°	23±3
φ7mm	0.4-0.5	0.05-0.25	40-50	18°	50°	28±3
Φ7.94m m	0.4-0.5	0.05-0.25	40-50	18°	50°	40±3
Φ9.52m m	0.45-0.55	0.05-0.25	45-55	18°	50°	45±3
Aluminium Alloy: 1060, 3003, 3103, AA3003H, etc.						

Aluminium High Frequency Welded Tube

➤ Product Category

a. Aluminium Flat Oval Welded Tube For Radiators (Radiator Tube)

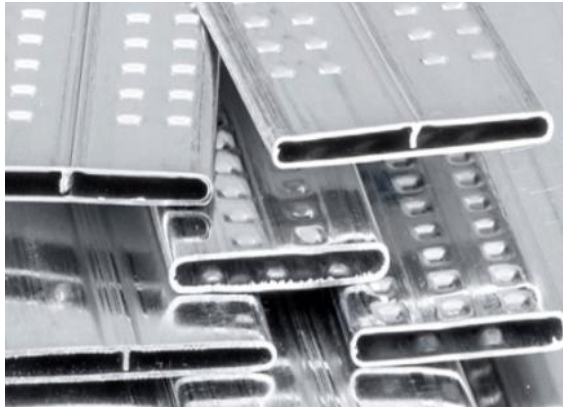

❖ Specifications:

- Flat oval welded tubes vary from 12mm to 60 mm in width.
- Multiple-chambered tube, dimpled tube, and end-free tube are available.
- Aluminium strip is as thin as 0.24 mm.
- A wide range of aluminium alloys is available.

b. Aluminium Welded Tubes With Inserted Turbulators

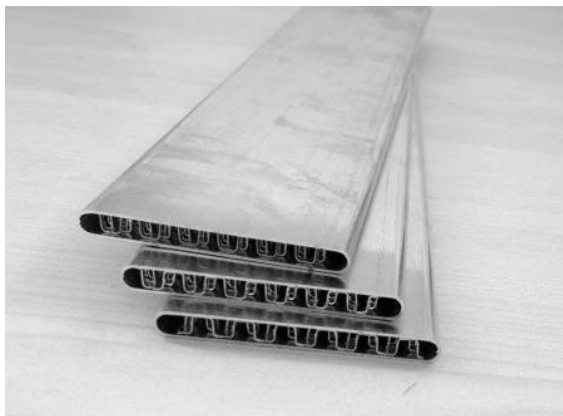

Description: Aluminium welded tubes with inserted turbulators, known as a high frequency welded aluminium CAC tube, are mainly used for charge air coolers (intercooler) and oil coolers. To increase the necessary turbulences and hence increase the heat transfer performance of cooling devices, we offer tubes including inserted turbulators, rolled or stamped. This kind of tube is also called an inner finned welded tube or tube-fin high

frequency welded tube, because the inserted turbulators are made of aluminium fin.

- ❖ Specifications of charge air coolers (intercooler tube)

Specifications	Dimensions		
	Width	Thickness	Material Wall Thickness
C32x7.6x0.26	32±0.06	7.6±0.06	0.26
C50x8.08x0.45	50±0.06	8.08±0.06	0.45
C64x8.08x0.5	64±0.06	8.08±0.06	0.5
C64x7.72x0.32	64±0.06	7.72±0.06	0.32
C43x4.3x0.4	43±0.05	4.3±0.06	0.4
C32x7.6x0.4	32±0.06	7.6±0.06	0.4
C68x10.2x0.5	68±0.2	10.2±0.12	0.5
C57.1x10.195x0.4	57,1±0.15	10.195±0.115	0.4
C57.1x10.2x0.5	57,1±0.2	10.2±0.12	0.5
C50.62x10.2x0.4	50.62±0.09	10.2±0.05	0.4
C80x7.88x0.4	80±0.06	7.88±0.06	0.4
C90x7.5x0.4	90±0.06	7.5±0.05	0.4
C100x7.73x0.4	100.05±0.1	7.73±0.05	0.4
C61.87x7.85x0.35	61.87±0.1	7.85±0.07	0.35
C32x7.88x0.4	32±0.06	7.88±0.06	0.4
C40x7.72x0.32	40±0.06	7.72±0.06	0.32
C50.05x7.67x0.4	50.05±0.1	7.67±0.05	0.4

❖ Specifications of oil cooler tube

Specifications	Width	Thickness	Wall Thickness
O43x4.3	43±0.05	4.3±0.06	0.4
O16x4	16±0.05	4±0.05	0.5
O27.66x3.19	27.66±0.05	3.19±0.05	0.5
O34.7x3	34.7±0.05	3±0.05	0.5

c. Round/D-type Aluminium Welded Tubes For Condenser Collectors (Header Pipe)



❖ Specifications of round aluminium welded tubes (Header Pipe)

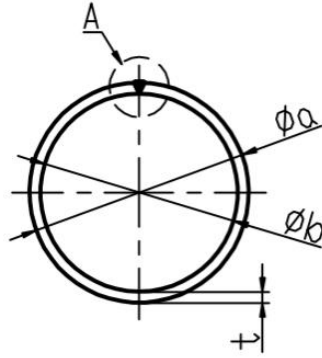

Round Collector	OD/a(mm)	Wall Thickness/t(mm)
P20x1.15	20±0.1	1.15
P20x1.2	20±0.1	1.2
P20x1.5	20±0.1	1.5
P20x1.12	20±0.1	1.12
P28x1.0	20±0.1	1.3
P28x1.6	28±0.12	1.6
P33.4x1.5	33.40-0.2	1.5
P30x1.2	30+0.20	1.2
P30x1.5	30±0.05	1.5
P30x1.6	30±0.1	1.6
P19x1.3	19±0.05	1.3
P15.88x1	15.88±0.2	1
P19x1.2	19	1.2
P31.6x1.5	31.6±0.2	1.5
P25x1.3	25±0.1	1.3
P38x2	38±0.15	2
P22x1.3	19±0.05	1.2
P26x1.9	26±0.08	1.9
P25x1.8	25±0.08	1.8
P23x1.7	23±0.08	1.7
P20.4x1.7	20.4±0.1	1.7

❖ Specifications of D-type aluminium welded tubes (D-type Header Pipe)

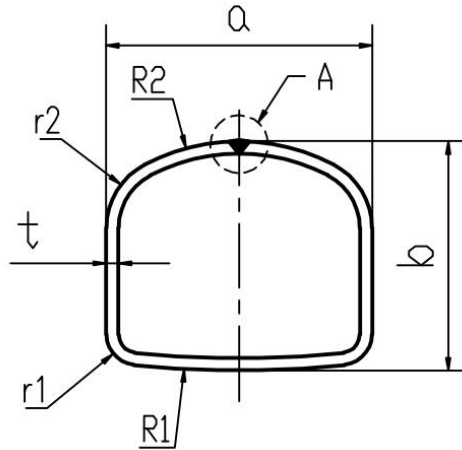

D-type collector	Dimensions(mm)		
	Width(a)	Height(b)	Material Wall Thickness(t)
PD20.4x18	20.4±0.1	18±0.1	1.2
PD20x18	20±0.1	18±0.1	1.0
PD20.4x18.5	20.4±0.05	18.5±0.05	1.0
PD25.5x19	25.5±0.1	19±0.05	1.2
PD15.1x12.7	15.1±0.05	12.7±0.05	1.2
PD16×16	16	16	1.2
PD18×19	18	19	1.0
PD18×22	18	22	1.5
PD20×17	20	17	1.0
PD21.4×19.4	21.4	19.4	1.0
PD21×18	21	18	1.0
PD21×19.5	21	19.5	1.0
PD23.35×22.4	23.35	22.4	1.6
PD25.5×19	25.5	19	1.2
PD26×22.4	26	22.4	1.2
PD32×18	32	18	1.2
PD32×18	32	18	1.8
PD32×23	32	23	1.2
PD38×27	38	27	2.0
PD44×19	44	19	1.0

d. Aluminium Condenser Header Pipe



Description: Aluminium condenser header pipe is also called aluminium condenser manifolds, is one of the important parts of HVAC systems.

The header consists of an oversized pipe, which ensures speed and pressure are so small as to have a negligent effect upon the inlet resistance in the individual circuits. The fluorine in the air conditioner is compressed by the compressor to produce

high-temperature and high-pressure liquefied gas, which is condensed by the condenser and then becomes a low-temperature and high-pressure liquid, and enters the collector tube.

❖ **Specifications:**

Cladding type: Single side cladding material, double sides cladding material.

Cladding layer: 4045, 4343, 4043, 7072 and other anti-corrosion layers, can be added with zinc as needed.

Material temper: M, H14, H16, H18, or according to customer requirements.

Cladding rate: 10±2 or according to customer requirements.

Core layer: 3003, 3305, 6063, etc.

Outer diameter: 9-61mm.

Wall thickness: 1-3.0mm.

Processing: High-frequency welding.

❖ **Types of Aluminium Condenser Header Pipe**

- Cladding Aluminium Condenser Header Pipe
- Punched Aluminium Condenser Header Pipe

❖ **Specifications of round aluminium condenser header pipe**

Size	Code	Drawing No.	Dimensions		
			T Width	Thicknes s	Material Thicknes s
P20x1.15	P01-20x1.15A	P20x1.15-01A	20±0.1	17.7±0.1	1.15
P20x1.2	P01-20x1.2B	P20x1.2-01B	20±0.1	17.6±0.1	1.2
P20x1.5	P01-20x1.5C	P20x1.5-01C	20±0.1	17±0.1	1.5
P20x1.12	P01-20x1.12D	P20x1.12-01D	20±0.1	17.76±0.1	1.12
P20x1.0	P01-20x1.0E	P20x1.0-01E	20±0.05	18±0.05	1.0
P20x2.05	P01-20x2.05F	P20x2.05-01F	20±0.05	16±0.05	2.05
P28x1.6	P02-28x1.6A	P28x1.6-02A	28±0.12	24.8±0.12	1.6
P28x1.5	P02-28x1.5C	P28x1.5-02C	28±0.1	25±0.1	1.0

P33.4x1.5	P03-33.4x1.5A	P33.4x1.5-03A	33.40-0.2	30.40-0.2	1.5
P30x1.2	P04-30x1.2A	P30x1.2-04A	30+0.20	27.6+0.20	1.2
P30x1.5	P04-30x1.5B	P30x1.5-04B	30±0.05	27±0.05	1.5
P30x1.6	P04-30x1.6C	P30x1.6-04C	30±0.12	26.8±0.1	1.6
P19x1.3	P05-19x1.3A	P19x1.3-05A	19±0.05	16.4±0.05	1.3
P19x1.2	P05-19x1.2B	P19x1.2-05B	19±0.05	16.6±0.05	1.2
P15.88x1	P06-15.88x1A	P15.88x1-06	15.88±0.05	13.88±0.05	1
P31.6x1.5	P07-31.6x1.5A	P31.6x1.5-07	31.6±0.2	28.60-0.1	1.5
P25x1.8	P08-25x1.8B	P25x1.8-08B	25±0.1	21.4±0.1	1.8
P25x1.5	P08-25x1.5C	P25x1.5-08C	25±0.1	22±0.1	1.5
P38x2	P09-38x2A	P38x2-09A	38±0.15	34±0.1	2
P38x2.2	P09-38x2.2B	P38x2.2-09B	38±0.15	33.6±0.1	2.2
P22x1.3	P10-22x1.3A	P22x1.3-10A	22±0.075	19.4±0.075	1.3
P22x1.27	P10-22x1.27B	P22x1.27-10B	22±0.05	19.46±0.05	1.27
P26x1.9	P11-26x1.9A	P26x1.9-11A	26±0.15	22.2±0.15	1.9
P23x1.7	P12-23x1.7A	P23x1.7-12A	23±0.1	19.6±0.1	1.7
P22.28x0.6	P13-22.28x0.6A	P22.28x0.6-13A	22.28±0.1	21.08±0.1	0.6
P17.5x1.2	P14-17.5x1.2A	P17.5x1.2-14A	17.5±0.1	15.1±0.1	1.2
P23.2x1.3	P15-23.2x1.3A	P23.2x1.3-15A	23.2-23.3	20.6-20.7	1.3
P27x1.3	P16-27x1.3A	P27x1.3-16A	27±0.05	24.4±0.05	1.3
P16x1	P17-16x1A	P16x1-17A	16±0.05	14±0.05	1
P16x1.2	P17-16x1.2B	P16x1.2-17B	16±0.05	13.6±0.05	1
P15.88x0.6	P06-15.88x0.6B	P15.88x0.6-06B	15.88±0.1	14.68±0.1	0.6
P20.15x1.15	P18-20.15x1.15A	P20.15x1.15-18A	20.15±0.05	17.85±0.05	1.15
P21x2	P19-21x2A	P21x2-19A	21±0.05	17±0.05	2
P20.1x1.25	P20-20.1x1.25A	P20.1x1.25-20A	20.1±0.05	17.6±0.05	1.25
P32x2.5	P21-32x2.5A	P32x2.5-21A	32±0.15	27±0.15	2.5
P32x2.3	P21-32x2.3C	P32x2.3-21C	32±0.15	27.4±0.15	2.3
P32x1.8	P21-32x1.8B	P32x1.8-21B	32±0.1	28.4±0.1	1.8
P30.26x1.55	P22-30.26x1.55A	P30.26x1.55-22A	30.26±0.05	27.14-27.2	1.55
P39.4x2.7	P23-39.4x2.7A	P39.4x2.7-23A	39.4±0.15	34±0.1	2.7
P12x1	P24-12x1	P12x1-24A	12±0.05	10±0.05	1.0
P33.3x1.5	P25-33.3x1.5A	P33.3x1.5-25A	33.3±0.1	30.3±0.1	1.5
P22.22x1.6	P26-22.22x1.6A	P22.22x1.6-26A	22.22±0.05	19.02±0.05	1.6

❖ Specifications of D-type Aluminium Condenser Header Pipes (include D and square types)

Size	Code	Drawing No.	Dimensions		
			T Width	Thicknes s	Material Thicknes s
PD20.4x18	PD01-20.4x18	PD20.4x18-01	20.4±0.1	18±0.1	1.2
PD20x18	PD02-20x18	PD20x18-02	20±0.1	18±0.1	1
PD20.4x18. 5	PD03-20.4x18. 5	PD20.4x18.5-0 3	20.4±0.0 5	18.5±0.05	1
PD25.5x19	PD04-25.5x19	PD25.5x19-04	25.5±0.1	19±0.05	1.2
PD15.1x12. 7	PD05-15.1x12. 7	PD15.1x12.7-0 5	15.1±0.0 5	12.7±0.05	1.2

Composite Aluminium Tube (Al-Al Composite Tube)



Description: Aluminium composite tube refers to as al-al composite tube, making an addition layer of weldable aluminium smoothly attach to the ordinary tube. Generally, the internal material is 3003 or 6061, and the external layer is 4343 or 6063, that the two kinds of aluminium alloy closely joint together. The additional layer makes tubes can be welded with other material. This kind of composite

aluminium tubes is widely used as a condenser header pipe in the air conditioning heat exchanger field.

➤ Product Category

- a. High frequency welded composite tube

This kind composite tube adopts high-frequency welding technology, by welding the clad aluminium sheet into a composite aluminium tube.

- b. Extruded seamless tube

There are two extruded tubes with different diameters and using different alloys. The

small one is made of 3003 or 6063 aluminium alloy, and the bigger one is made of 4343 or 4045 alloys, and then insert the small tube into the bigger tube. Two kinds of alloy tubes are tightly and uniformly combined with cold drawing.

➤ **Specifications**

Outer Diameter	Φ8 ~ Φ43 mm
Wall Thickness	1.0 ~ 3.0 mm
T/ID	3.0% ~ 8.0%
Base material	3003, 6063
Brazing layer	4343, 4045
Composite rate	5% ~ 12%

Aluminium Foil For Air Conditioner



➤ **Alloy and Temper:**

1030BH26/3102H26, 8011-O/8011H22/8011H24, 1100H22, 8006-O/8006H22, 7072-O, clad foil 4343+3003+4343, 4343+3003+4045

➤ **Specifications:**

- Thickness: 0.047-0.2mm
- Coil ID: φ405/505/605mm, Coil OD: 1600-2500mm, Width: 600-1700mm
- Coil ID: φ76/152/200mm, Coil OD: 500-1200mm, Width: 200-1300mm

➤ **Three kinds of air conditioner foil:**

- Bare aluminium foil

- Clad aluminium foil
- Hydrophilic aluminium foil

➤ **Applications**

- EV Automobile: Heat exchange system(condenser, evaporator) and Cooling system for battery(water cooling plate, battery case)
- Heat Exchanger in Automobile: Radiator, Air cooler, Condenser, evaporator, HVAC, Oil Cooler, etc.
- Air Cooling System: Plate finned Radiator
- Air Conditioner Industry: Household AC, Commercial AC, Central Controlled AC
- Power Station
- Air Cooling: Radiator

Aluminium Clad Foil For Heat Transfer



Aluminum alloy strip sheet



Aluminum alloy clad sheet



Aluminum alloy clad foil



Aluminum alloy clad tube material

➤ **Specifications:**

a. High Strength Aluminium Clad Foil for Radiator Tube Stock Material

Aluminium alloy: 3003(4043/4045/7072)

Thickness: 0.15-0.4mm

Delivery temper: H24

Pre-brazed Tensile strength 190-220MPa

Pre-brazed Yield Strength Min150MPa

Pre-brazed Grain size (core material): Fiber

Post-brazed Tensile strength Min185MPa

Post-brazed Grain size (core material) Min70µm

Post-brazed Electric Potential (core material): -630+/-20mV

Post-brazed Electric Potential (water side material): -780+/-20mV

Clad brazing material: 10.5+/-2.0%

Water side material: 17+/-2.5%clad

Application: tube material for heat exchanger tube, radiator tube, intercooler tube

b. High Strength Aluminium Foil for Fin Material

Aluminium alloy: 4343+3003+4343
Thickness: 0.0475-0.08mm+/-0.0025mm
Delivery temper: H14
Pre-brazed Tensile strength: 190-215MPa
Pre-brazed Elongation: Min1.0%(targetMin1.5%)
Pre-brazed Electrical Conductivity Min45%IACS
Post brazed tensile strength>135Mpa
Post-brazed Electrical Conductivity Min41.5%IACS
Post-brazed Grain size Min200µm
Post-brazed Electric Potential -750+/-10mV
Application: air conditioner, condenser

c. High Corrosion Resistance Aluminium Foil for Clad Fin Stock Material

Aluminium alloy: 4343/AA3003/4343(weight loss%)
Thickness: 0.06-1.2mm
Delivery temper: H16
Post brazing tensile strength>165Mpa
Post brazing yield strength>60Mpa

d. Single Layer Aluminium Foil

Thickness:0.07/0.08mm
Delivery temper: H16
Post brazing tensile strength>150Mpa
Post brazing yield strength>50Mpa
SWAAT test 4 weeks, performance is 10% better than 4343/AA3003/4343(weight loss%)

Learn more about aluminium products, visit www.chaluminium.com.